

ART.2254 - 2259



DiSmart

Swiveling deaerator for heating systems.

- 360° swiveling female-female connections
- 360° swiveling air vent valve
- 1/2" bottom connection with plug
- Connection to pipelines: 3/4" - 1" (**Art.2254**)
- Connection to pipelines for copper pipe: Ø22 - Ø28 (**Art.2259**)
- **Patented**

1 DESCRIPTION

Air inside the system can cause corrosion in the interior of the pipe and damage to installed components (such as pumps), leading to malfunctions, loss of heat exchange efficiency and noise in the system.

The DiSmart deaerator, with compact size and 360° swiveling connections, is specially designed to remove air bubbles from the circulating water in heating and cooling systems.

The cartridge and the swiveling air vent valve are patented and guarantee the best efficacy and versatility.

2 WORKING PRINCIPLE AND CONSTRUCTION DETAILS

The deaerator is provided with an internal chamber which reduces flow rate and decreases the drag force, facilitating separation of air.

Inside this chamber a cartridge is placed transversally to the direction of the flow, acting as a barrier to the water and reducing its kinetic energy, so that air bubbles rise upward.

This effect is reinforced by the use of tongues on the vertical bars of the cartridge, which drives the air upwards.

The **DiSmart** can be installed on the pipeline in either vertical or horizontal position, as the part with threaded connections can rotate 360° around its own axis.

The automatic air vent can rotate through 360° and purging can be carried out without needing to shut down the system.

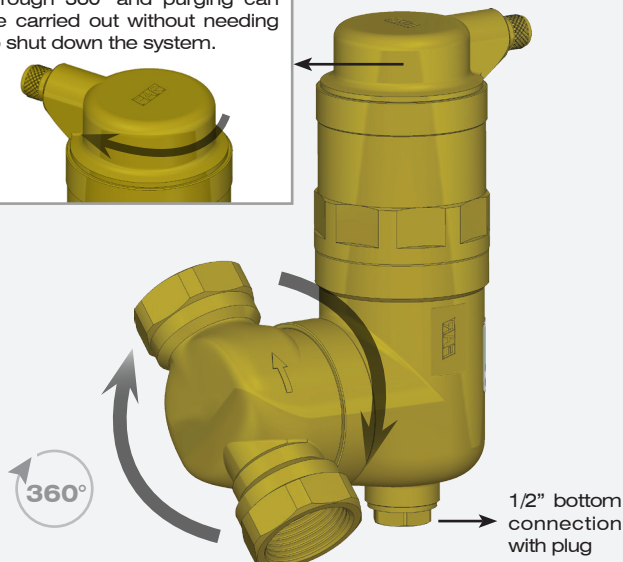

With no air in the circuit, the water inside the valve maintains the float in such a position that it can close the shutter.

The presence of air in the system reduces the water level in the valve and consequently the float level drops and the water discharge opens.

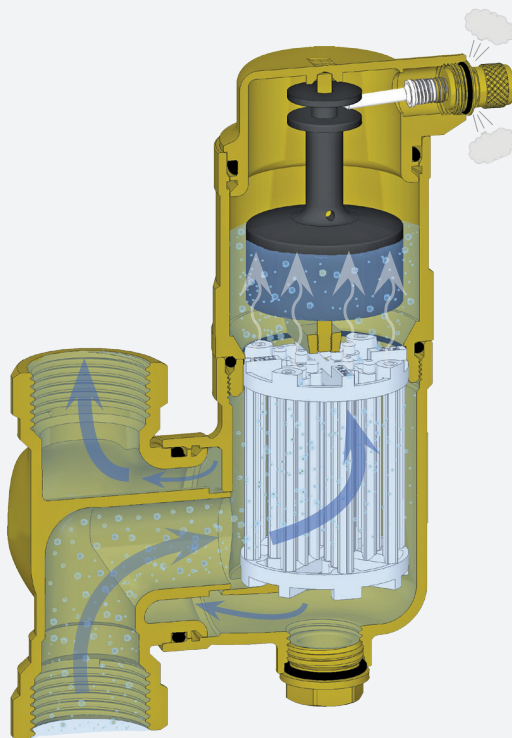

3 INSTALLATION

The ideal deaerator position in the heating system is on the supply pipe just after the boiler, where the flow temperature is high. This is because, as the water is heated in the boiler there is a possibility of bubbles being formed, causing damage to components or malfunctioning. **It is recommended that the deaerator is installed between two shut-off valves for maintenance.**

⚠ Attention! For proper operation the dirt separator should always be installed in a vertical position.

Horizontal installation

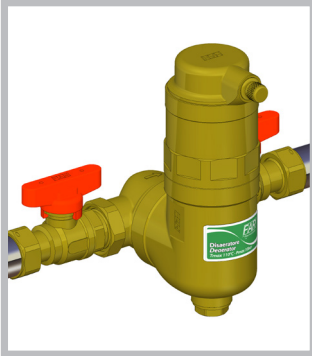

Vertical installation

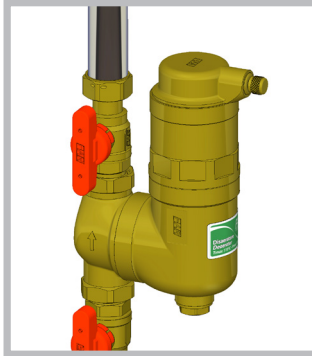

RECOMMENDED INSTALLATION

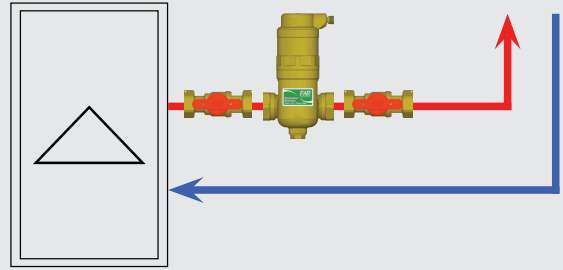

⚠ For cooling systems the deaerator should be installed in the return line.

4 MAINTENANCE

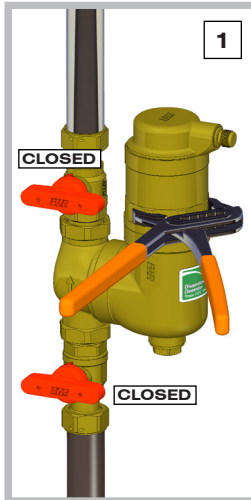

In order to carry out maintenance, it is first necessary to close the shut-off valves located before and after the deaerator (**picture 1**). Then unscrew the upper body using a plumbing wrench and remove the cartridge for cleaning (**picture 2**).

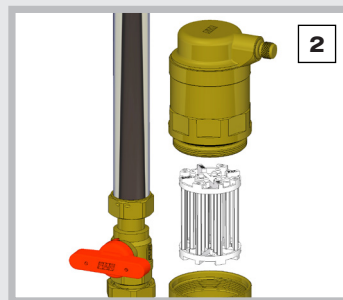

In the event of leakage from the air vent valve it is necessary to clean or replace it as follows: remove the cap and use a 4 mm Allen wrench to unscrew the air vent valve. Then proceed with cleaning or replacement (**picture 3**).

For correct insertion of the stem on the float, turn upside down the cap and screw the air-vent valve again (**picture 3**).

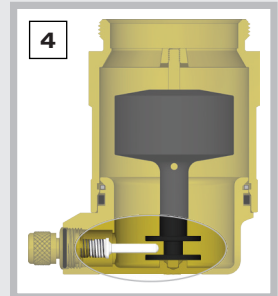
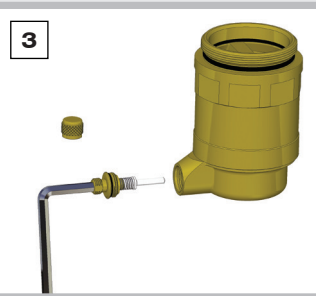

5 FLUID-DYNAMIC FEATURES

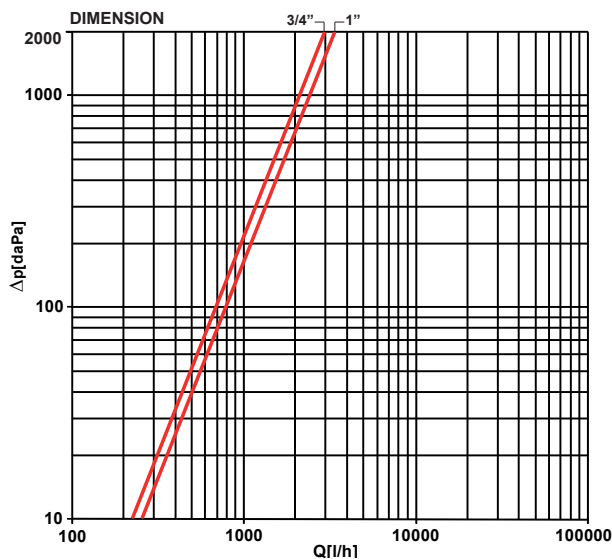

3/4" Kv=6,8 m³/h

1" Kv=7,5 m³/h

6 TECHNICAL FEATURES

- Body: CB753S brass
- Float: Polypropylene
- O-Ring: EPDM-P
- Max. working temperature: 110°C
- Nominal pressure: 10 bar
- Cartridge: PA6

7 DIMENSIONAL FEATURES

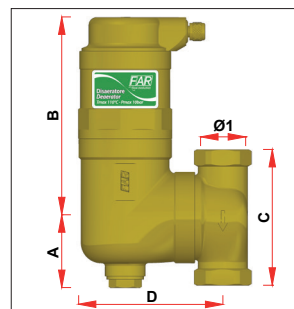

ART. 2254

CODE	Ø1	A	B	C	D
2254 34	G3/4	46	130	88	93
2254 1	G1	46	130	102	93

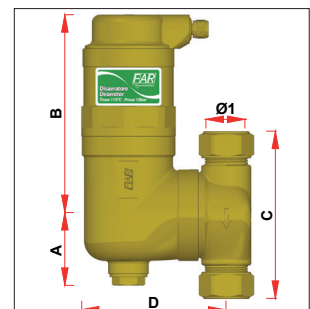

ART. 2259

CODE	Ø1	A	B	C	D
2259 3422	Ø22	46	130	108	93
2259 128	Ø28	46	130	110	93